

TECHNICAL INFORMATION

CITIZEN QUARTZ

Cal. No. 8962 ※

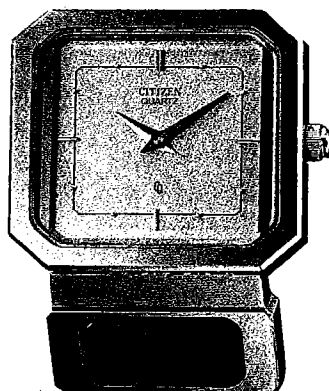

 **CITIZEN**

1. OUTLINE

This is a new combination watch for gentlemen and developed on the basis of Cal. No. 8960-02 (combination watch for ladies) which is precedently marketed.

It features quite a unique design, that is, the digital watch section occupies a part of a watchband and independently of an analog watch which is the main function of this watch.

- 1) A combination watch for gentlemen with quite a new design – the digital watch section occupies its position at a part of a watchband.
- 2) It is easy to operate the multiple functions of the watch with just a piece of crown.
- 3) An analog electromagnetic correction system (hands moving per hour) facilitates an easy correction of a time differential.

2. SPECIFICATIONS

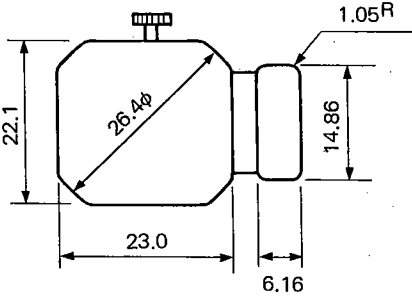
Caliber No.		8962-02
Type		Combination quartz crystal watch (Hour/minute hands of analog watch)
Movement		
	Thickness (Incl. power cell)	Analog watch: 2.5mm Digital watch: 2.1mm
Accuracy		±20 sec./month at normal temp.
Oscillation		32,768Hz
Display system		FE nematic LC (liquid crystal) 2-split multiplex drive
Converter		Bipolar step motor (20 sec. step movement of hands)
Integrated circuit		C/MOS-LSI (1 unit)
Working temp. range		0°C ~ 55°C (32°F ~ 131°F)
Adjustment of time rate		DFC (digital frequency control) system (Unit time of measurement 10 sec. & with no control terminal)
Displays	Time	Hour, minute & A/P
	Second	Second
	Calendar	Month & date
	Alarm	Hour, minute (ON only) & OFF
	Chime	:00 (ON only)/OFF
	Timer	00'00" (1H count, setting unit 1 sec.)
Additional functions		<ul style="list-style-type: none"> ● 12/24 hour switching ● Alarm monitor ● Time differential correction ● Automatic calendar (28 days of Feb.)
Power cell (Silver oxide)		Parts No. : 280-53 (1 unit) Maker code : SR721 (Ag ₂ O/KOH) Size : 7.9mmφ x 2.1 mm ^t Nominal voltage : 1.55V Nominal capacity : 25mAH Lifetime : About 2 years (20 sec. alarm, 24 hourly chimes & 7.5 sec. Timer per day)

3. HANDLING INSTRUCTIONS

3-1. Nomenclature and mode marks

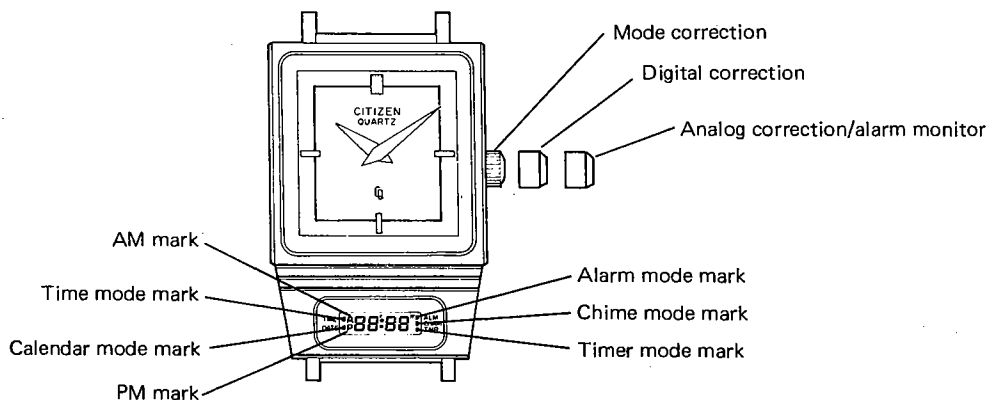

3-2. Mode switch

As illustrated below, the display modes are switched consecutively by turning the crown at its normal position (0-step position).

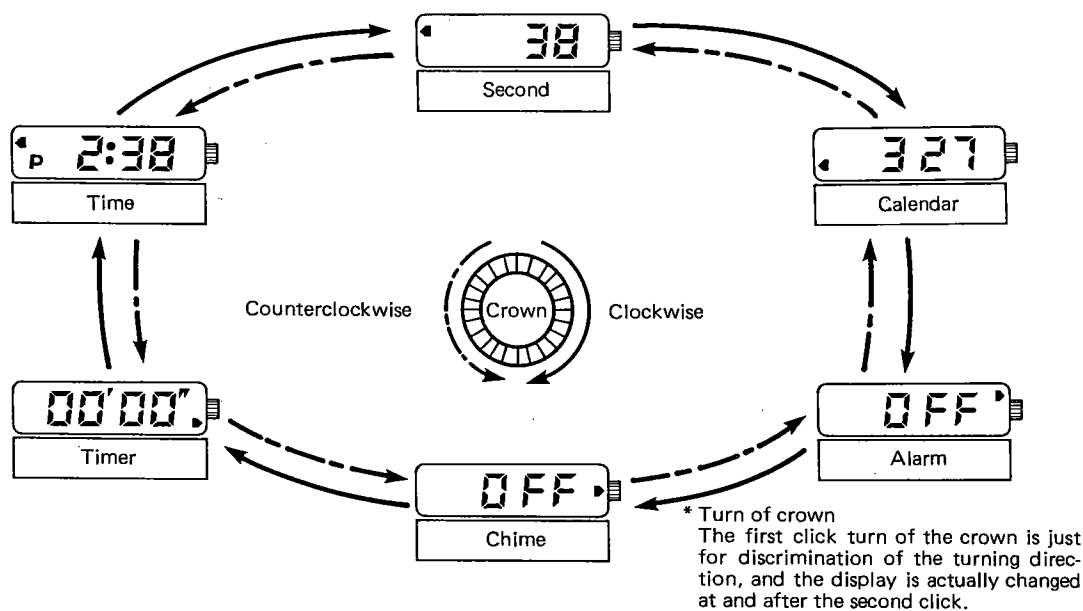

3-3. Correction of mode

1) Correction of time

Digital watch

Two different ways of correction are available for the digital watch by operating the crown in the time mode or second mode.

a) Correction in second mode

- (1) The second resets to 0 and the time counting stops when the crown is pulled out one step.
- (2) The mode is switched in 2 seconds to the correction of hour and minute.
- (3) The crown is turned clockwise to correct hour and counterclockwise to correct minute respectively.
- (4) The time counting starts again at 0 second by setting the crown at its normal position after correcting hour and minute.

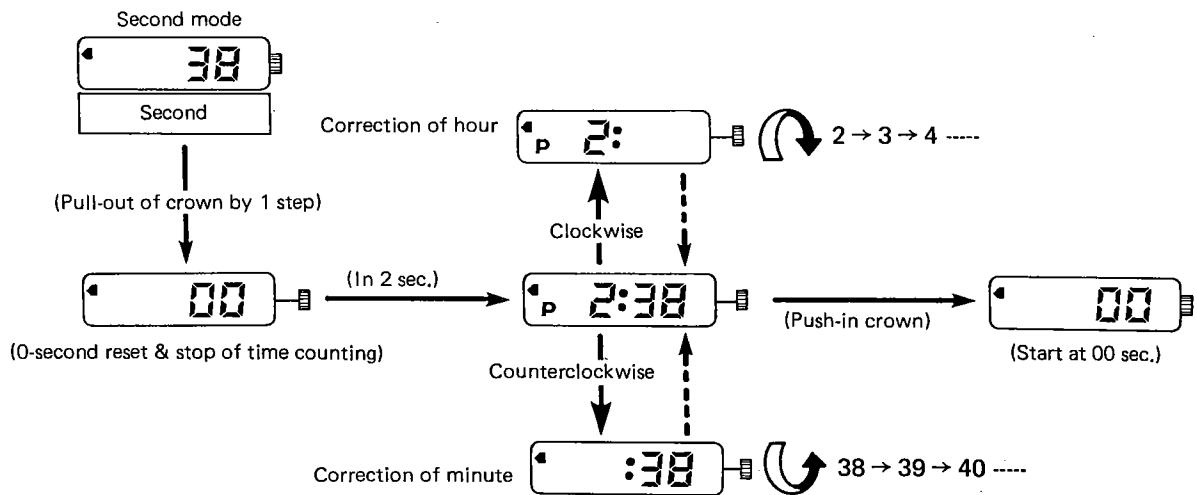

b) Correction in time mode

- (1) Refer to a).
- (2) The time counting does not stop in this mode of correction. Therefore no error is caused to second although the crown is reset at its normal position after a correction after a correction of time.

Analog watch

Two different ways of correction are available for the analog watch by operating the crown in the time mode or the second mode of the digital watch.

a) Correction in second mode

- (1) The second hand is reset to 0 second and time counting stops when the crown is pulled out two steps. Thus an analog correction mode is obtained.
- (2) The time is advanced by one hour with a 1/4 clockwise turn (1 click) of the crown. Give another 1/4 turn to the crown to set a halfway time.
- (3) A 1/4 counterclockwise turn of the crown advances 20 seconds.
- (4) The time counting starts again at 0 second when the crown is reset at its normal position after correcting hour and minute.
In this case, the digital second also starts at 0 second synchronously with the analog second.

b) Correction in time mode

- (1) Refer to a).
- (2) The second counting is not discontinued in this mode of correction. This can maintain the synchronization between the analog second and the digital second.

2) Synchronization of second between digital and analog watches (Correction of second)

- (1) The analog minute is set at an exact minute in the second mode, and then the crown is pushed into its normal position. Thus both analog and digital watches start at 0 at one time.
- (2) Both digital and analog seconds are reset to 0 and the time counting stops when the crown is pulled out one step in the second mode.
- (3) Both digital and analog watches start at 0 second when the crown is pushed into its normal position.

O-reset at n digital seconds

Digital second	Analog output of correction
$0 < n < 30$	Wait for n-second count*
$30 < n < 40$	+2 pulses
$40 < n < 60$	+1 pulse

- * A count wait mode is cancelled if the analog second is corrected in a wait mode for 0-second reset or in the count wait mode.
- * One pulse shows a 20-second movement of the second hand.
- * When the second is reset to 0, a minute is carried with 29 counted and 30 cut for both analog and digital watches.

3) Correction of calendar

- (1) The calendar is corrected by pulling out the crown by one step in the calendar mode.
- (2) The month and the day are corrected with clockwise and counterclockwise turns of the crown.
 - * A non-existing day (e.g., April 31) if set with be automatically corrected to the first day of the next month (e.g., May 1).
 - * The calendar of this watch is based on a 28-day system of February. Therefore February 29 must be set manually with a leap year.

4) Operation of alarm

- (1) The ON and OFF are switched alternately when the crown is pulled out one step and then pushed into the normal position in the alarm mode.
- (2) An hour/minute display shows an ON state.
- (3) The crown is turned to correct hour and counterclockwise to correct minute respectively.
 - * The alarm rings for 20 seconds and can be stopped with an operation of the crown in any function mode.

5) Operation of chime

- (1) The ON and OFF are switched alternately when the crown is pulled out one step and then pushed into the normal position in the chime mode.
- (2) A :00 display shows an ON state.

6) Operation of timer

a) Timer set

- (1) The timer is set by pulling out the crown by one step in the timer mode. (A sound of confirmation is heard.)
- (2) The crown is turned clockwise to correct minute and counterclockwise to correct second respectively.
 - * As second is reset to 0 when minute is set, the minute must be set first when the second setting is desired. (The timer is based on a 1-hour count system with the setting unit of 1 second.)

b) Start/stop

- (1) After the alarm time is set, the counting starts when the crown is pushed and stops when the crown is pulled out one step.
 - * When the time is counted up, a timer tone is delivered 10 ~ 20 seconds.
 - * A sound of confirmation is delivered every time the timer starts and stops.

7) 12/24 hour switching operation

(1) The switching is possible between the 12 and 24 hour display modes by pulling out the crown by one step and then pushing it into the normal position in the time mode.

8) Alarm monitor

As shown below, four types of alarm monitors are available with this watch. The monitor sound rings 1 ~ 2 minutes with each type of alarm monitor. The monitor sound is stopped by pushing in the crown.

- a) Continuous sound in calendar mode
- b) Alarm sound in alarm mode
- c) Chime sound in chime mode
- d) Timer sound in timer mode

9) Display of mode marks

Each mode mark is displayed when the alarm, chime and timer are active respectively in each of the time, second and calendar modes.

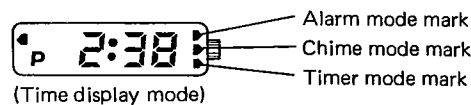

10) Correction of time differential

The hour/minute can be corrected for the analog watch when the crown is pulled out two steps in the time display mode. Under such conditions, a time differential is corrected by turning the crown clockwise. In this case, the analog second is also corrected synchronously with the digital second.

■4. STRUCTURE OF MOVEMENT

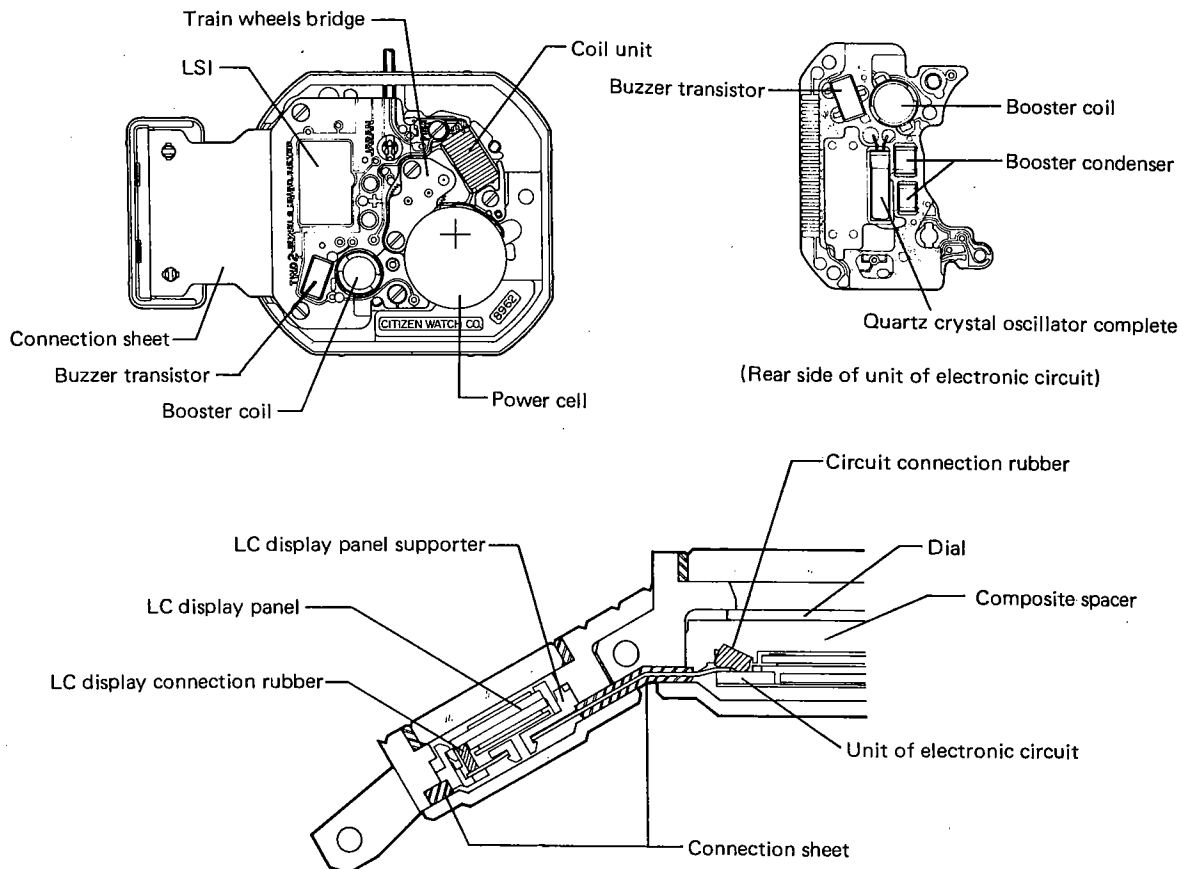

5. DISASSEMBLY/ASSEMBLY OF MOVEMENT WITH LUBRICATION

Disassembling procedure : ① → ③⑤

Assembling procedure : ③⑤ → ①

(A digital block is formed by setting each parts into the LC display panel holder.)

Marks of lubrication

- ⑤ V-Lube oil
- ④ A-Lube oil
- ⑥ F-Lube oil
- ⑦ CA-1 oil

(The use of F-Lube oil is recommended for relevant areas although the F-Lube is replaceable with A-Lube oil.)

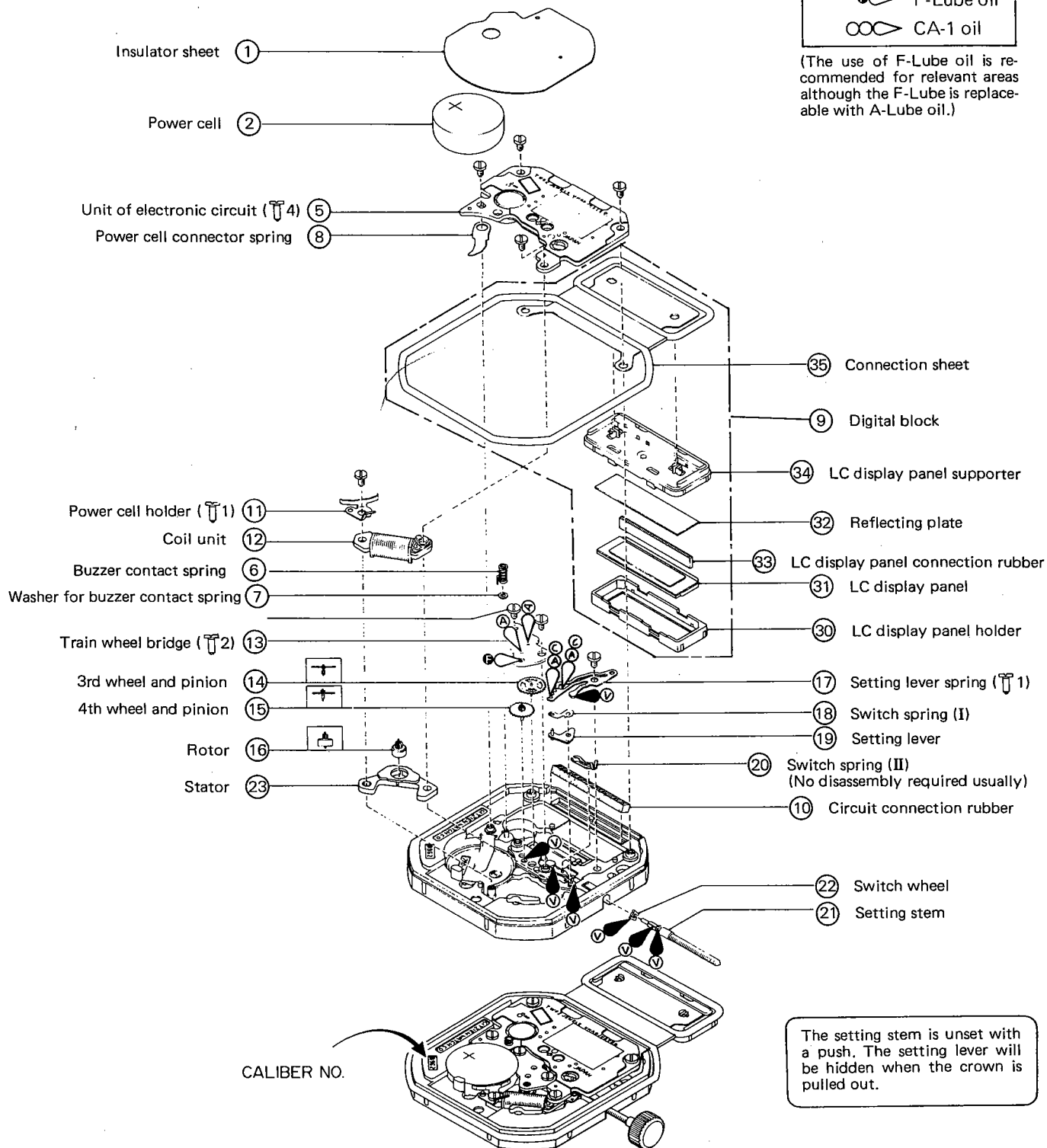

* The dial is pushed into the case and fixed there. Pry up lightly the dial at a slit (→ mark) and unset the dial.

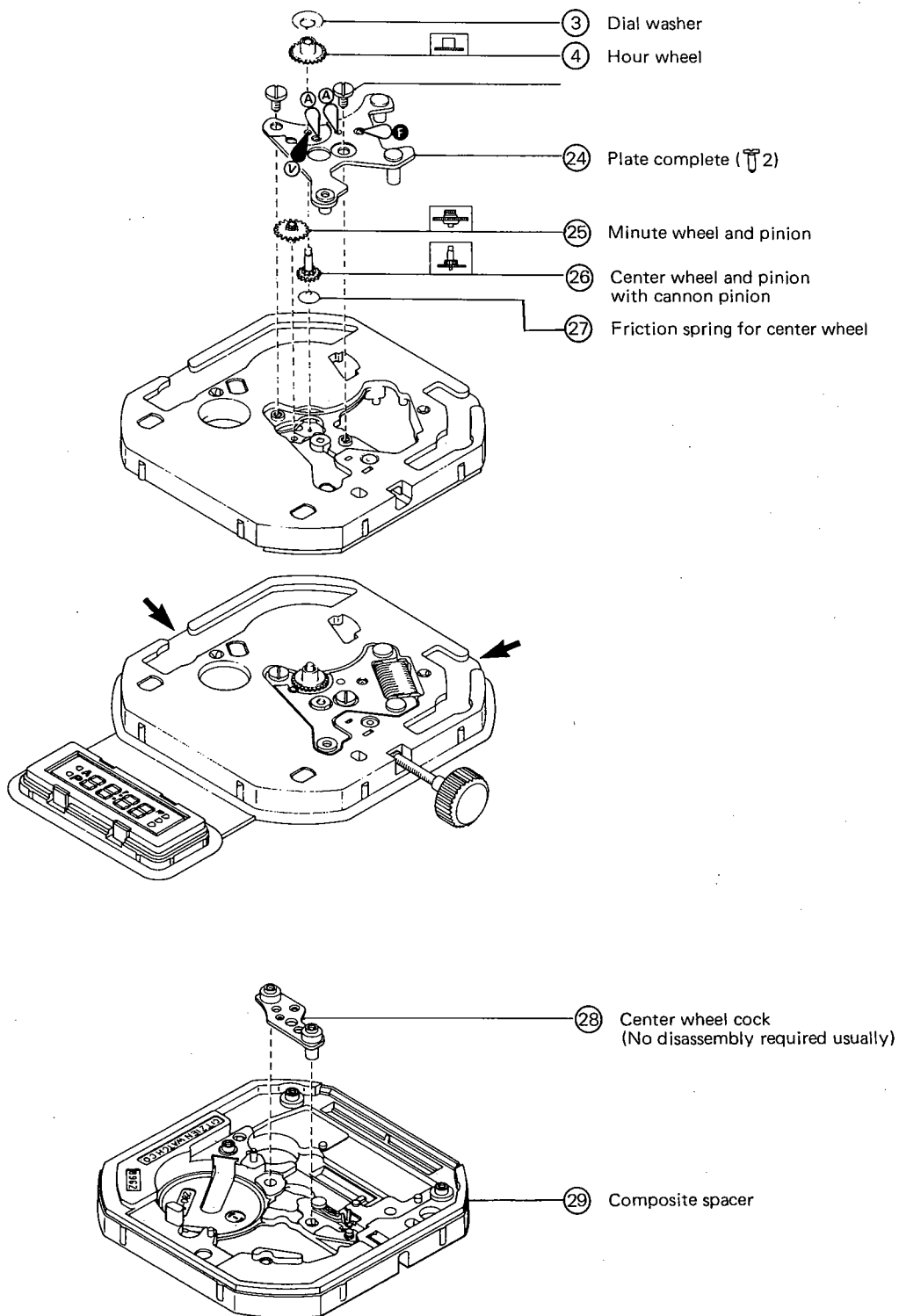

6. NOTE ON DISASSEMBLY/ASSEMBLY AND LUBRICATION

1) Digital block

(1) Disassembly

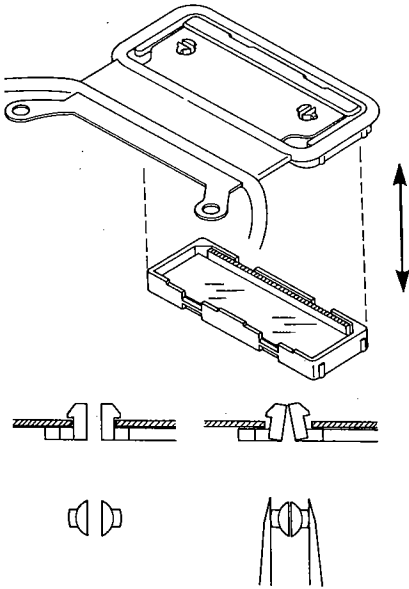

a) LC display panel supporter and LC display panel holder

The 4 catches of an LC display panel supporter hook an LC display panel holder to form a digital block.

When disassembling, the LC display panel holder is unset by releasing the hook at the 4 catch parts by means of a driver or the like.

b) Connection sheet and LC display panel supporter

A connection sheet is fixed by two joggles of an LC display panel supporter.

When disassembling, the connecting sheet is unset from the LC display panel supporter by holding the joggles of the panel supporter and releasing the hook of the joggles as illustrated left.

(2) Assembly

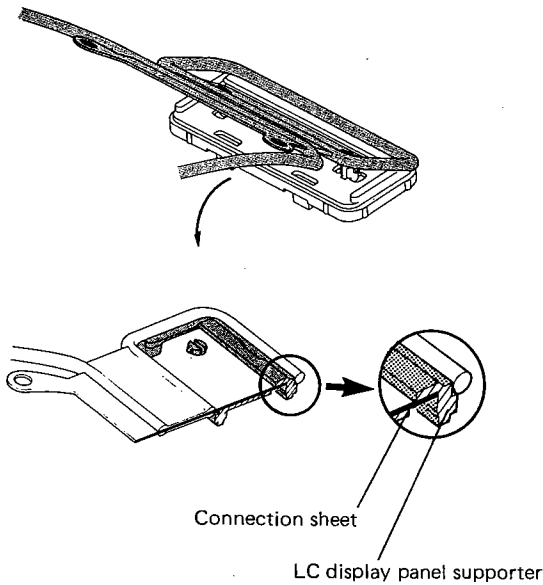

a) Connection sheet and LC display panel supporter

A connecting sheet is slid partially and put into an LC display panel supporter so that the contact part between the connection sheet and an LC display panel connection rubber is set at the side of the LC display panel.

Then the joggles of the LC display panel supporter are pushed and hooked to the two holes of the connecting sheet.

b) Assembling procedure of digital block

- ① A connection sheet and an LC display panel supporter are assembled together as described above.
- ② An LC display panel, reflecting plate and LC display panel connection rubber are set into an LC display panel holder in that order.
- ③ The 4 hook parts of an LC display panel supporter are hooked and fixed to an LC display panel holder as if the assembled connection sheet and LC display panel holder were put over the LC display panel holder which is mentioned in ②.

2) Setting direction of circuit connecting rubber

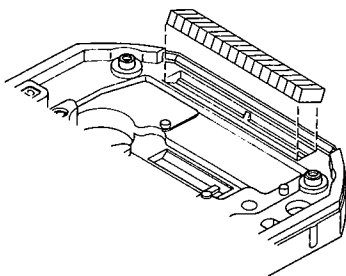

Be careful of the setting direction of the circuit connecting rubber when it is set into a composite spacer.

3) Handling of minute wheel and pinion

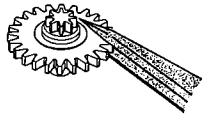

- As illustrated, hold the minute wheel at the gear part not at the pinion part. The pinion part is easily impaired since it is made of plastic. And the damage of the pinion part will stop the watch function.

4) Setting of friction spring for center wheel

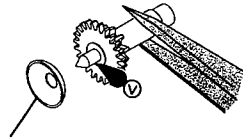

Friction spring for center wheel
(Be careful of setting direction.)

- The V-Lube oil is first supplied to the friction spring for center wheel, and then the spring is set into the center wheel. The center wheel is then set into the center wheel cock.

5) Lubrication of setting lever spring

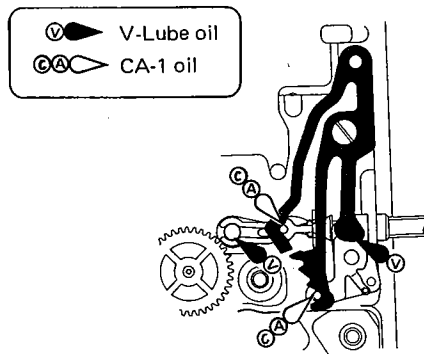

- As illustrated left, the CA-1 oil is supplied to a contact part between the setting lever spring and the setting lever as well as to a contact part between the setting lever spring and the switch lever. At the same time, supply the V-Lube oil to other necessary areas.

* The V-Lube oil used in place of the CA-1 oil will affect the pull-out actuation of the crown. Furthermore the CA-1 oil can be preserved longer than the V-Lube oil.

So that the lubrication of the V-Lube oil must be avoided at the area where the use of the CA-1 oil is designated.

6) Handling of connection sheet

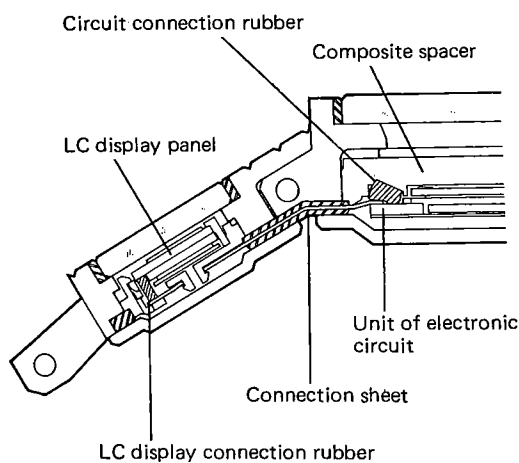

- A connection sheet is formed by unifying a sheet substance which secures the conduction between the digital and analog sections and is protected by silicone rubber and the packings which ensure the water resistance of both cases of the digital and analog watches.
- A part of the rubber which protects the sheet substance is exposed in the form of a complete watch. Avoid using a metallic brush like a wire brush or the like to clean the dust or soil at the exposed part, and use other types of cleaning brushes.
- Hold the connection sheet with a tweezers or the like and at the rubber part protecting the sheet substance not at the pattern part of a copper foil. Avoid folding the sheet too much to avoid a disconnection.
- Like a unit of electronic circuit, avoid using alcohol or the like to wash the connection sheet but use rodico to clean the dust or soil.
- The packing is unified with the connection sheet to ensure the water resistance of the case, and no lubrication is needed to the packing with silicone oil since the packing is made of silicone rubber.
- In case a part of the packing has flaws or breakage, the sheet having such defects must be replaced with a nondefective one in order to maintain good water resistance.

7) Setting of unit of electronic circuit

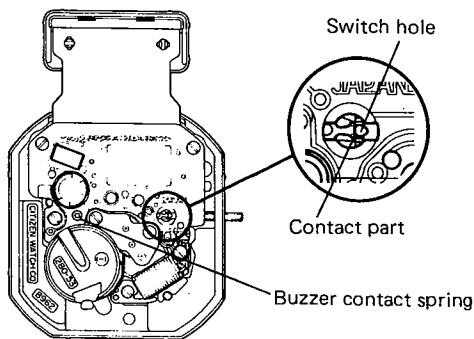

- When setting the unit of electronic circuit, the screws must be driven carefully so that the contact part of the switch spring (II) is exposed through the switch hole of the unit of electronic circuit. The damage of the said contact part will deteriorate the switch function.
- Be careful not to miss the assembly of a buzzer contact spring.

8) How to exchange switch spring (II)

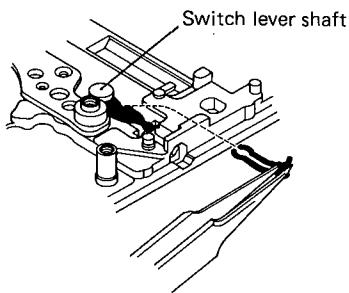

- No disassembly is usually required for the switch spring (II).
- The switch spring (II) is easily unset by holding the spring with a tweezers as illustrated and then pulling it out toward the crown. The spring is set by holding it as illustrated, and the spring is set as if it held the switch lever shaft. Take great care when handling the switch spring (II) since it is easily deformed.

9) Setting of power cell

The following two defective phenomena may sometimes occur when a power cell (power source) is put into a completed movement.

- a) **Both digital and analog corrections are impossible although the crown is pulled out one or two steps and then turned after the power source is applied, and at the same time the display mode is switched improperly.**
- b) **A non-existing day is displayed erroneously.**

The above phenomena are not due to the defects of an IC and need no replacement of a unit of electronic circuit.

- Therefore the defect a) will be settled by resetting the crown at its normal position (0-step position).**
- While the defect b) will be solved by turning the crown respectively.**

10) How to set/unset movement

- The movement is set into a case in the following procedure.

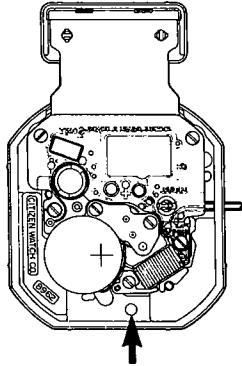

- (1) The digital part (digital block) is set into the case.
- (2) As illustrated left, the composite spacer is slid toward an arrow mark. Then the analog part is set into the case.
 - * If the pressure is applied to the surface of the unit of electronic circuit, the coil, etc., the watch will be stopped.
 - * Avoid pushing the protecting rubber part of the connection sheet with a sharp matter like the tip of a tweezers, etc. The damage of the rubber part will cause the impairment of a pattern or the defective resistance to water.
- (3) The caseback of the digital part is fixed with screws.
- (4) The caseback of the analog part is fixed with screws.
 - * Set the packing of the connection sheet, the LC display panel supporter and the composite spacer into the corresponding cases in a correct way. Then each caseback is closed tight.

- Reverse the above-mentioned procedure to unset the movement from the case.

- (1) The composite spacer is pried upward at the area indicated by an arrow in the above diagram and by means of a tweezers or the like, and then the analog part is taken out of the movement.

2) Details of troubleshooting and adjustment (With use of power cell strap for checking)

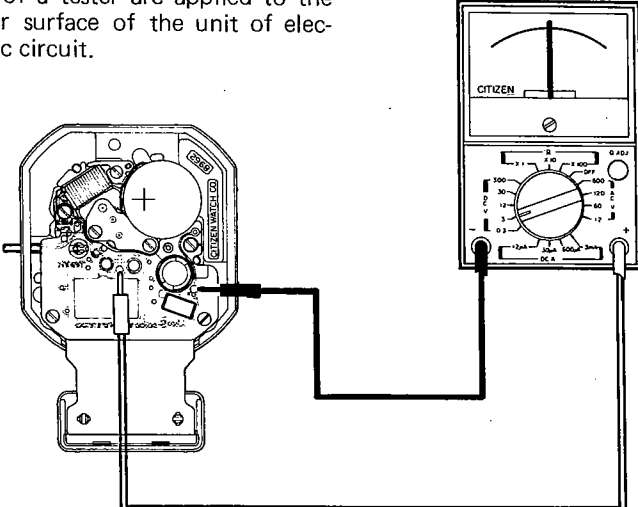
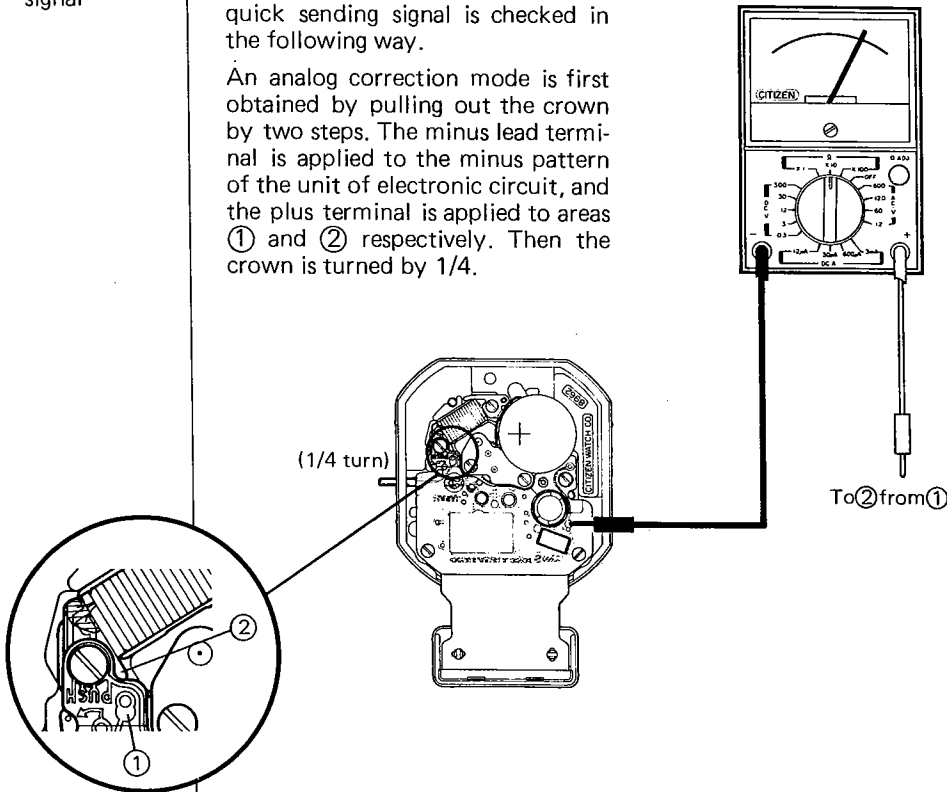
Checking items	How to check	Results and treatment
<p>1 Measurement of power cell voltage</p>	<p>As illustrated below, the lead terminals of a tester are applied to the upper surface of the unit of electronic circuit.</p> <div style="text-align: center;">  <p>Tester range: DC 3V</p> </div> <p>* It is impossible to obtain the correct value of measurement if the screws for unit of electronic circuit are loosened.</p> <p>* The power cell must be set again if some abnormal operation occurs when the power cell is set into the movement.</p>	<div style="border: 1px solid black; padding: 5px; margin-bottom: 10px;"> <p>Over 1.5V</p> <p>→ Nondefective</p> </div> <div style="border: 1px solid black; padding: 5px;"> <p>Under 1.5V</p> <p>→ Replacement of power cell</p> </div> <div style="border: 1px solid black; padding: 5px; margin-top: 20px;"> <p>The power cell if used 2 years or longer must be replaced with new one although the old cell shows an output of 1.5V or more.</p> </div>
<p>2 Check of output signal</p>	<p>There is no defect if the quick sending signal can be confirmed. The quick sending signal is checked in the following way.</p> <p>An analog correction mode is first obtained by pulling out the crown by two steps. The minus lead terminal is applied to the minus pattern of the unit of electronic circuit, and the plus terminal is applied to areas ① and ② respectively. Then the crown is turned by 1/4.</p> <div style="text-align: center;">  <p>(1/4 turn)</p> <p>To ② from ①</p> </div> <p>* ② indicates a coil terminal which can be seen through the play of the unit of electronic circuit.</p> <p>* Avoid giving damage to the coil.</p>	<p>Plus terminal applied to ① and ② :</p> <p>Tester pointer swinging up to about 0.2V</p> <p>→ Nondefective</p> <p>No output signal checked at ①</p> <p>→ Replacement of unit of electronic circuit</p> <p>No output signal checked at ②</p> <p>→ Check of 4 and no fault detected → Replacement of unit of electronic circuit</p>

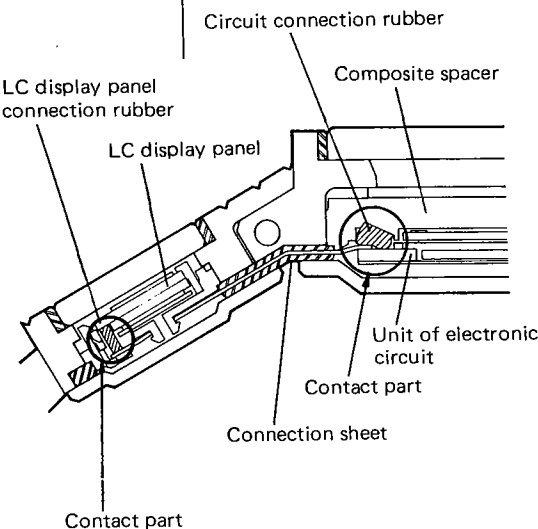
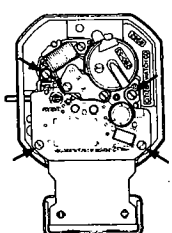
Checking items	How to check	Results and treatment
<p>3 Check of connection part of connection sheet</p>	 <p>● The digital driving is controlled by a circuit of the analog side.</p> <p>● Digital driving output fed from the circuit is transmitted to the circuit pattern, connection rubber, connection sheet, connection rubber and LC display panel in that order.</p> <ul style="list-style-type: none"> ● Check whether the electrode part of the LC panel has the crack or break, soil, etc. ● Check whether the dust or stain stick to the electrode of the unit of electronic circuit and whether the pattern has some impairment. ● Check whether the LC display connection rubber and the connection rubber of the unit of electronic circuit are twisted, worn out or set in a defective way. ● Check whether the dust or soil stick to the electrode of the connection sheet and the pattern has some impairment. ● Check whether the silicone rubber protecting the electrode part of the connection sheet has some damage. <p>● Check whether the LC display panel rubber is confused with the connection rubber of the unit of electronic circuit when they are assembled.</p>	<p>Crack or break → Replacement of LC display panel</p> <p>Soil → To be cleared</p> <p>Dust or stain → To be cleaned</p> <p>Impairment of pattern → Replacement of unit of electronic circuit</p> <p>Twist or wear → Replacement of connection rubber</p> <p>Defective setting → To be set again</p> <p>Dust or soil → To be cleared</p> <p>Impairment of pattern → Replacement of connection sheet</p> <p>Damage of rubber → Replacement of connection sheet</p> <p>Wrong setting → To be set again</p>
<p>4 Check of connection part</p>	 <p>The signals is not transmitted to the coil and the digital block from the unit of electronic circuit if the screws for the electronic circuit are not driven tight.</p> <p>At the same time, contact becomes defective if some foreign matter exists on the lower surface of the unit of electronic circuit and on the upper surface of a coil terminal.</p>	

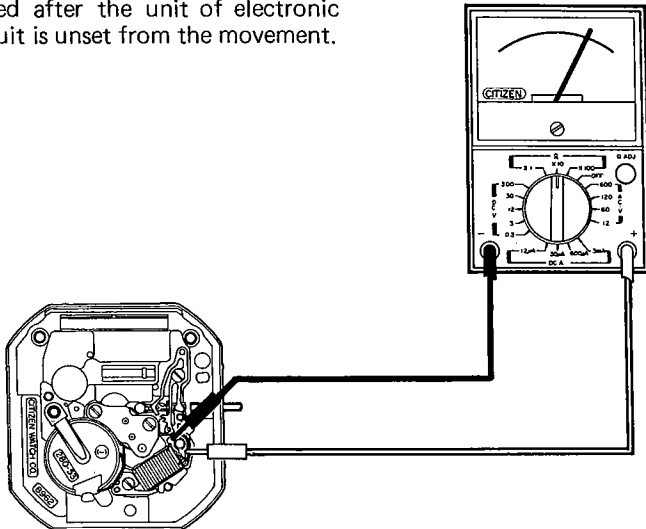
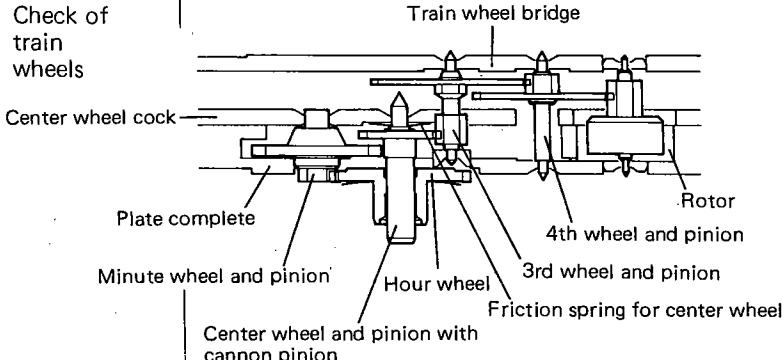
Checking items	How to check	Results and treatment
5 Measurement of coil resistance	<p>The lead terminals are applied to both terminals of the coil as illustrated after the unit of electronic circuit is unset from the movement.</p> <div style="text-align: right; margin-bottom: 10px;">Tester range: X10Ω</div>  <p style="text-align: center;">* Be careful not to damage the coil.</p>	<p>Measured value of coil resistance:</p> <div style="border: 1px solid black; padding: 2px; display: inline-block; margin-bottom: 5px;">1.5 ~ 1.9KΩ</div> <p style="text-align: center;">→ Nondefective</p> <div style="border: 1px solid black; padding: 2px; display: inline-block; margin-bottom: 5px;">Outside 1.5 ~ 1.9KΩ</div> <p style="text-align: center;">→ Replacement of coil unit</p>
6 Check of train wheels		<ol style="list-style-type: none"> 1. Check whether the gears engage each other in a smooth way. 2. Check the lubrication is appropriate for each gear. 3. Check whether the friction spring for center wheel is set assuredly with no deformation. (A deformation of the friction spring will cause a defective movement of the minute hand.)
7 Check of dial side	<ul style="list-style-type: none"> ● Make sure of the engagement between the hour wheel and the minute wheel. Particularly pay good attention to the damage of the pinion part of the minute wheel which is due to the setting of the hour wheel. ● Make sure that the setting stem has no bend and that the lubrication is proper. 	<p>Both the minute wheel and the hour wheel are made of plast and must be handled with great care. The damage of the pinion part of the minute wheel will stop the working of the watch.</p>
8 Measurement and adjustment of time rate	<p>The time rate is measured with a Citizen Quartz Tester.</p> <p>a) Measurement of time rate (Measurement time range: 10 sec.) This watch applies the DFC system, and the analog part is designed so that a compensating pulse is delivered with every 10 seconds like the digital part although the analog watch features a 20-second step movement of hands. Therefore the measurement of time rate is possible at the analog part.</p> <p>b) Adjustment of time rate No adjustment of time rate is carried out on the market for this watch since a complete adjustment is already given to the time rate at the plant side. If the time rate has a big error, the unit of electronic circuit must be replaced with new and nondefective one.</p>	<div style="border: 1px solid black; padding: 5px; margin-top: 10px;"> <p>If the time rate is measured in the direct sunlight or the light of an incandescent lamp, a shift is caused to the time rate to unable the accurate measurement.</p> </div>

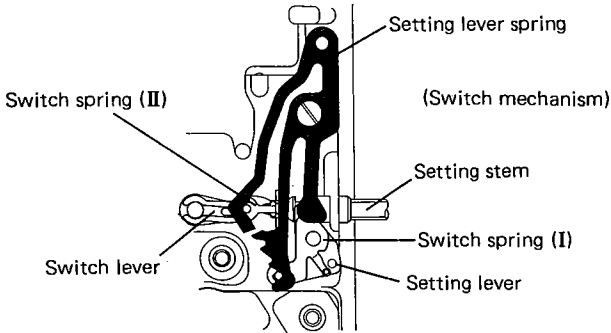
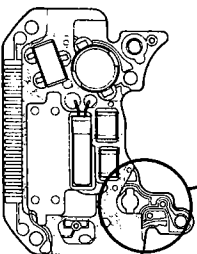
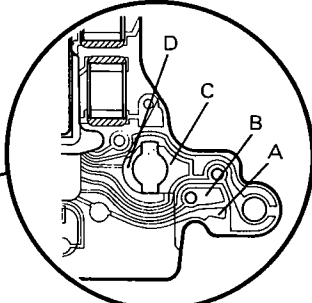
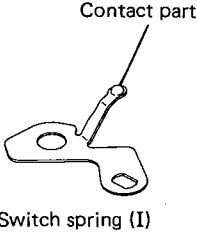
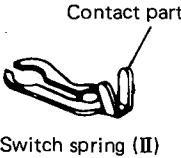
Checking items	How to check	Results and treatment
<p>9 Confirmation of using condition of watch</p>	<ul style="list-style-type: none"> •The using condition of the watch is also checked because the watch will be affected by the environment under which is used (in terms of the magnetic field, an extreme temperature or humidity, the impact, etc.). •Make sure how many days have passed since the time rate was adjusted last. 	
<p>10 Check of switch mechanism</p>	<p>•The working of the switch mechanism is checked as follows.</p> <p>a) Switch mechanism of pull-out of crown Both the setting lever and the switch spring (I) work at one time when the crown is pulled out. Then the contact part of the switch spring (I) touches the patterns A and B on the rear side of the unit of electronic circuit. Thus a switching action is performed.</p> <p>b) Switch mechanism of turn of crown The switch wheel flips the switch lever left and right with a turn of the crown, and the switch lever (II) fitted to the switch lever moves in response to the switch lever. In this case, the contact part of the switch spring (II) touches the patterns C and D of the unit of electronic circuit. Thus a switching action is performed.</p> <div style="text-align: center;">  <p>(Switch mechanism)</p> </div> <div style="display: flex; justify-content: space-around; margin-top: 20px;"> <div style="text-align: center;">  <p>(Rear side of unit of electronic circuit)</p> </div> <div style="text-align: center;">  <p>(Magnified view)</p> </div> </div> <div style="display: flex; justify-content: space-around; margin-top: 20px;"> <div style="text-align: center;">  <p>Contact part Switch spring (I)</p> </div> <div style="text-align: center;">  <p>Contact part Switch spring (II)</p> </div> </div> <p>a) Switching check of pull-out of crown The contact part between the switch spring (I) and the unit of electronic circuit is checked in the following two cases.</p> <ol style="list-style-type: none"> (1) The correction mode (flashing of display and O-reset) is not obtained in each mode when the crown is pulled one step. (2) No monitor sound is produced in each mode (excluding hour/minute and second display modes) when the crown is pulled out two steps. 	<p>Wear or deformation of contact part of switch spring (I) → Replacement of switch spring (I)</p> <p>Soil of A and B patterns of unit of electronic circuit → To be cleared</p>

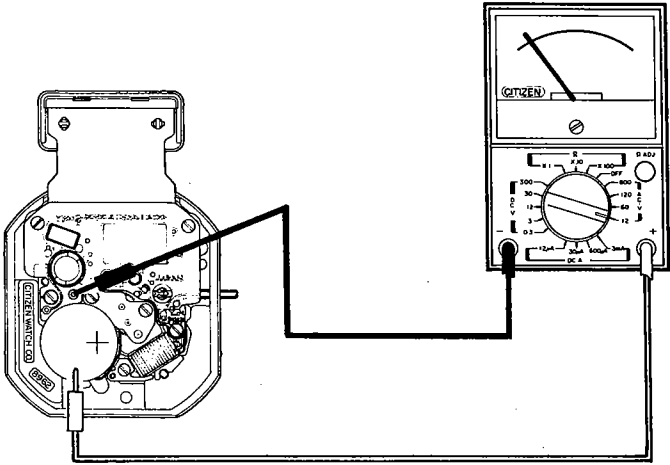
Checking items	How to check	Results and treatment
	<p>b) Switching check of turn of crown</p> <p>The fitting state is checked between the switch wheel and the switch lever as well as between the switch lever and the switch spring (II). At the same time, a contact part is checked between the switch spring (II) and the unit of electronic circuit in the following three cases.</p> <ol style="list-style-type: none"> (1) The mode switching is impossible when the crown is set at its normal position. (2) The correction is impossible when the crown is pulled one step (excepting the chime function). (3) The correction of time is impossible when the crown is pulled two steps. 	<p>Defective fitting → To be assembled again</p> <p>Wear or deformation of contact part of switch spring (II) → Replacement of switch spring (II)</p> <p>Soil of C and D patterns of unit of electronic circuit → To be cleared</p>
<p>11 Check of alarm mechanism</p>	<p>The alarm output is confirmed.</p> <p>A mode (calendar, alarm, chime or timer mode) in which the alarm monitor sound is delivered is set, and then the crown is pulled two steps.</p> <p>Under such conditions, the tester lead terminals are applied to the buzzer contact spring and the plus side of the power cell respectively as illustrated below. In this case, no definition is required for polarities between these two terminals.</p> <p>It is possible to confirm the alarm output clearly by using if the alarm monitor (continuous sound) given in the calendar mode.</p> <div style="text-align: center;"> <p>Tester range: AC 12V</p>  </div> <ul style="list-style-type: none"> ● The power cell holder is checked. The voltage is not applied to the sound generating part if the contact part of the power cell holder touching the caseback has some deformation, dust or soil. In such case, the case is not grounded either. ● The insulator sheet is checked. The insulator sheet is positioned by two pins provided on the upper surface of the unit of electronic circuit. If this sheet has a shift, the sound volume of alarm will be reduced or no alarm sound is produced. ● An inspection is also given to the damage, soil etc. of the piezo-electric element. 	<p>Tester pointer swinging → Nondefective</p> <p>No swinging of tester pointer → Replacement of unit of electronic circuit</p> <p>Deformation of spring → To be corrected or replaced</p> <p>Dust or stain → To be cleared</p> <p>Defective positioning of insulator sheet → To be set again</p>

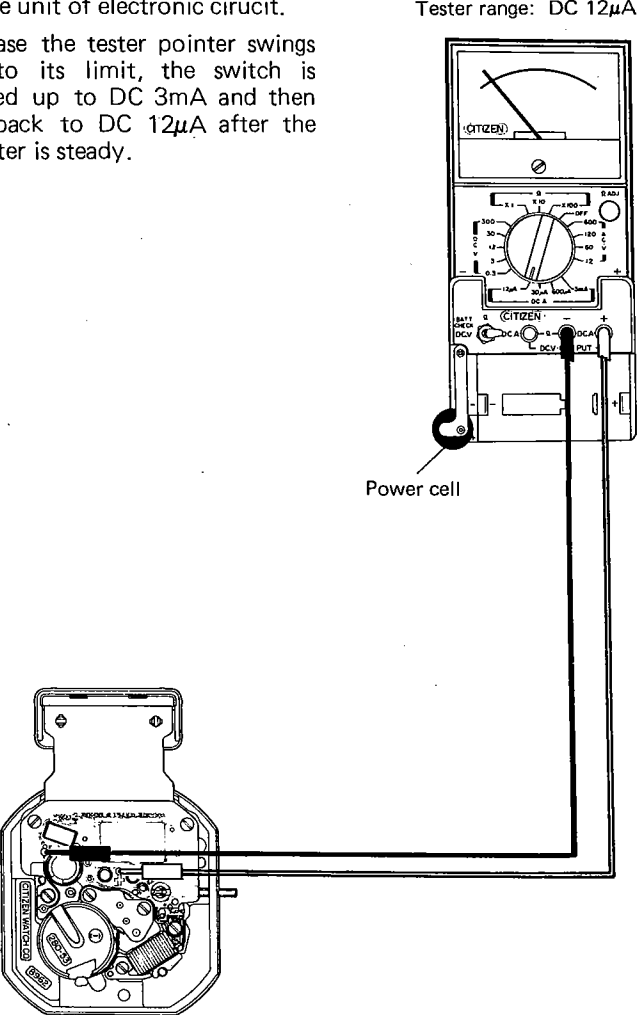
Checking items	How to check	Results and treatment
<p>12 Measurement of power consumption</p>	<p>●As illustrated, the tester lead terminals are applied to the patterns of the unit of electronic circuit.</p> <p>In case the tester pointer swings up to its limit, the switch is turned up to DC 3mA and then set back to DC 12μA after the pointer is steady.</p> <p>Tester range: DC 12μA</p>  <p>Power cell</p>	<p>1.3μA or less</p> <p>→ Nondefective</p> <p>Over 1.3μA</p> <p>→ Measurement with single unit of unit of electronic circuit</p>

Checking items	How to check	Results and treatment
	<p>● Measurement of power consumption with single unit of unit of electronic circuit</p> <p>The tester leads are applied to the patterns of the unit of electronic circuit as illustrated below.</p> <div data-bbox="532 394 1166 1291" style="text-align: center;"> <p>Tester range: DC 12μA</p> <p>Power cell</p> </div> <p>● Note on measurement of power consumption</p> <p>Avoid the measurement in such place where the direct sunlight or the light of an incandescent lamp is irradiated to the watch movement.</p> <p>The irradiation of such beams may sometimes increase the level of power consumption.</p> <p>The light of a fluorescent lamp gives no effect to the measurement.</p>	<div style="border: 1px solid black; padding: 2px; width: fit-content; margin-bottom: 10px;"> Under 1.2μA </div> <p>→ Nondefective</p> <div style="border: 1px solid black; padding: 2px; width: fit-content; margin-bottom: 10px;"> Over 1.2μA </div> <p>→ Replacement of unit of electronic circuit</p>

Checking items	How to check	Results and treatment
13 Check of appearance and functions	a) Check of appearance <ul style="list-style-type: none">● Make sure that the surface of the dial is completely free from dust or soil.● Make sure that the digital display has no fault at all. b) Check of functions <ul style="list-style-type: none">● Make sure that the switching action is smooth and accurate by means of the crown.● Make sure that the alarm monitor has no fault.● Make sure that the electromagnetic correction (analog correction) works in a normal and correct way.	

CITIZEN WATCH CO., LTD.
Tokyo, Japan